

ALUMINUM FRAME  
SIZE AND DRAINS  
(OUTSIDE VIEW)

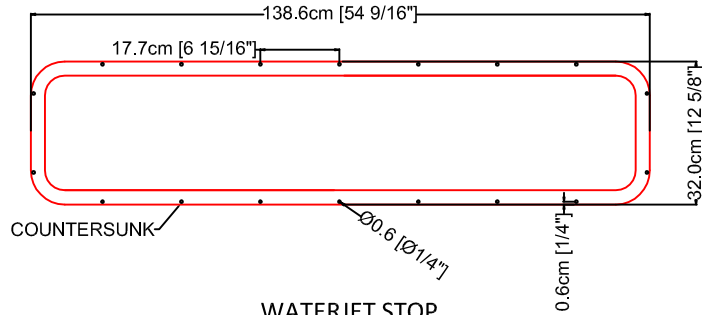

WATERJET STOP  
(AS VIEWED FROM INSIDE)

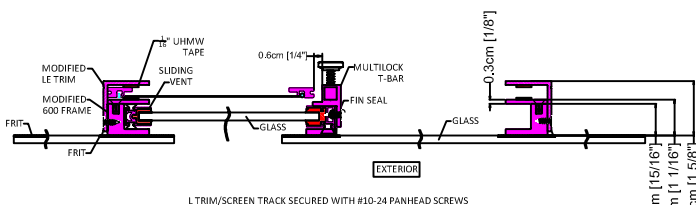
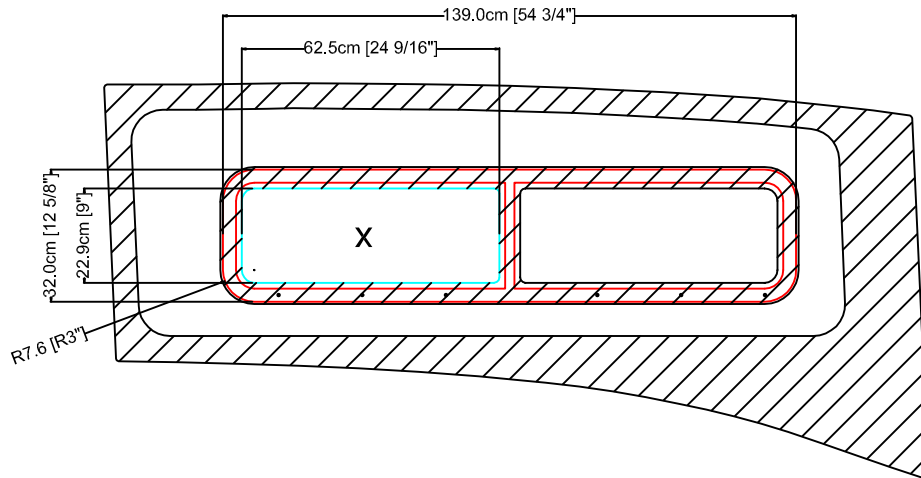

L TRIM/SCREEN TRACK SECURED WITH #10-24 PAN-HEAD SCREWS

CUSTOMER:	YCSYACHT
CUSTOMER PART NO:	
TYPE:	Cust-Win
CORNERS:	
GLASS:	
FINISH:	
BOLT HOLES:	
TRIM TYPE:	
BLOCK SIZE:	77 X 34

CUSTOM NOTES:

Glass in Glass Slider Bonded Aluminum Frame  
6mm 45% Grey Tempered Fritted Glass  
Slides Fwd to Aft  
C/W Sliding Screen  
Frit as per pattern, no dot matrix required  
No finish on glass edge  
PC Jet Black Aluminum Frame  
3" Radius corner on Frame

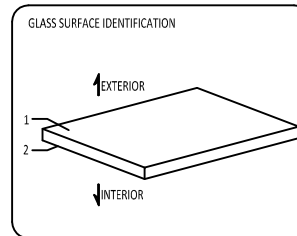
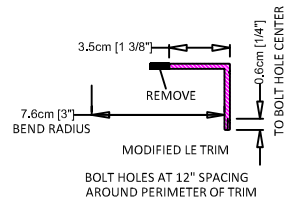

1- None 2- Frit

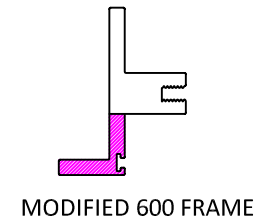

MODIFIED 600 FRAME

Vent Calcs  
65.0 - 90.0  
90.2 - 90.0  
155.2 - Cut Length  
T-Bar  
1 @ 29.2 90/90

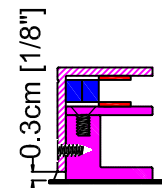

Modified LE Trim Calcs  
76.4 - 90.0  
105.0 - 90.0  
182.3 - Cut Length  
x 2  
+ 10 Add On

Screen Calcs  
64.7 - 90.0  
90.5 - 90.0  
155.2 - Cut Length  
T-Bar  
1 @ 29.5 90/90

Frame Calcs  
34.4 - 90.0  
168.4 - 90.0  
195.0 - Cut Length  
x2  
+ 10 Add On

1	2/27/18	RS			UPDATED CALCS AS PER PRODUCTION
REV	DATE	BY	APPR	ECN	DESCRIPTION

REVISIONS

THE INFORMATION CONTAINED IN THIS DRAWING CONSTITUTES THE INTELLECTUAL PROPERTY, INCLUDING, BUT NOT LIMITED TO, KNOWLEDGE, TRADE SECRETS, AND PROPRIETARY INFORMATION WHICH IS THE EXCLUSIVE PROPERTY OF ADVANTEC MANUFACTURING. ALL INFORMATION CONTAINED IN THIS DRAWING IS TO BE HELD IN THE STRICTEST CONFIDENCE BY THE RECIPIENT, AND IS NOT TO BE COPIED, DISCLOSED TO, OR TRANSMITTED TO ANY THIRD PARTIES WITHOUT THE EXPRESS WRITTEN AUTHORIZATION OF ADVANTEC MANUFACTURING.

UNLESS OTHERWISE SPECIFIED DIMENSIONS IN INCHES TOLERANCES Frame Heel +0/-1/4"	REF NO:		<p>26995 GLOUCESTER WAY, LANGLEY, B.C. CANADA 1-800-770-0455 FAX 604-607-9992 WWW.ADVANTECGLOBAL.COM</p>		
	DRAWN:	MT			
	DATE:	02/19/18			
	APPROVAL:				
SURFACE FINISH	SHEET:	PROJECT NO.:	DWG. NO.:	QTY.:	REV.:
3rd ANGLE PROJ.	SCALE:	OR1374	C-000561	1	1